

9900 and 9910 Cotton Pickers



TECHNICAL MANUAL

9900 and 9910
Cotton Pickers

TM1105 English

John Deere Des Moines Works

TM1105

LITHO IN U.S.A.
ENGLISH



9900 AND 9910 COTTON PICKERS

Technical Manual TM-1105 (May-83)

CONTENTS

SECTION 10 - GENERAL

- Group 5 - General Specifications
- Group 10 - Predelivery, Delivery, and After-Sale Services (9910)
- Group 15 - Tune-Up and Adjustment
- Group 20 - Lubrication
- Group 25 - Specifications and Torque Values

SECTION 20 - ENGINE

- Group 5 - General Information, Diagnosis, and Removal
- Group 10 - Cylinder Head, Valves, and Camshaft
- Group 15 - Cylinder Block, Liners, Pistons, and Rods
- Group 20 - Crankshaft, Main Bearings, and Flywheel
- Group 25 - Lubrication System
- Group 30 - Cooling System
- Group 35 - Timing Gear Train
- Group 40 - Specifications and Special Tools

SECTION 30 - FUEL SYSTEM

- Group 5 - Diagnosing Malfunctions
- Group 10 - Servicing Fuel System
- Group 15 - Specifications and Torque Values

SECTION 40 - ELECTRICAL SYSTEM

- Group 5 - Description and Wiring Diagrams
- Group 10 - Charging Circuit
- Group 15 - Starting Circuit
- Group 20 - Lighting and Accessory Circuits
- Group 25 - Specifications and Torque Values

SECTION 50 — POWER TRAIN

- Group 5 - Clutch and Main Drive Shaft
- Group 10 - Transmission
- Group 15 - Differential
- Group 20 - Auxiliary Gear Housing
- Group 25 - Final Drives
- Group 30 - Hydrostatic Drive
- Group 35 - Specifications and Torque Values

SECTION 60 - STEERING AND BRAKES

- Group 5 - Steering
- Group 10 - Brakes

SECTION 70 - HYDRAULIC SYSTEM

- Group 5 - General Information, Diagnosis and Tests
- Group 10 - Hydraulic Pump
- Group 15 - Hydraulic Valve
- Group 20 - Hydraulic Cylinders
- Group 25 - Steering
- Group 30 - Automatic Height Control
- Group 35 - Basket Compactor
- Group 40 - Specifications, Torque Values, and Special Tools

SECTION 80 - PICKING UNITS

- Group 5 - General Information, Diagnosis, Removal, Installation and Special Tools
- Group 10 - Grid Bars and Pressure Plates
- Group 15 - Spindles and Picker Bars
- Group 20 - Picker Drum, Drive Shaft and Gears
- Group 25 - Idler Gears and Bearings
- Group 30 - Doffer, Stub Shaft and Drive
- Group 35 - Moistener Column
- Group 40 - Drive Gear Housing, Slip Clutch, and Universal Joint
- Group 45 - Picking Unit Cabinet and Cam Track
- Group 50 - Specifications and Torque Values

SECTION 90 - OPERATOR'S CAB

- Group 5 - Pressurizer System
- Group 10 - Air Conditioning System
- Group 15 - Heating System
- Group 20 - Accessories
- Group 25 - Specifications and Torque Values

SECTION 100 - MISCELLANEOUS

- Group 5 - Air System
- Group 10 - Water System
- Group 15 - Dual Guide Wheels
- Group 20 - Single Guide Wheel
- Group 25 - Specifications and Torque Values

SECTION 110 - ALPHABETICAL INDEX

All information, illustrations and specifications contained in this technical manual are based on the latest information available at the time of publication. The right is reserved to make changes at any time without notice.

Copyright© 1983 DEERE & COMPANY
Moline, Illinois. All rights reserved
Previous Editions
Copyright© 1982 DEERE & COMPANY
Copyright© 1981 DEERE & COMPANY
Copyright© 1980 DEERE & COMPANY

INTRODUCTION

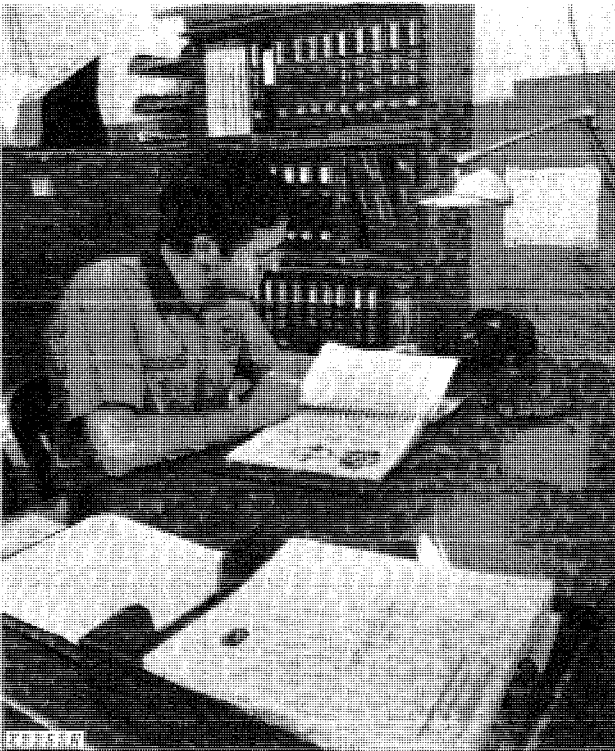

Use FOS Manuals for Reference

X2252N

This technical manual is part of a twin concept of service:

- **FOS Manuals—**for reference
- **Technical Manuals—**for actual service

The two kinds of manuals work as a team to give you both the general background and technical details of shop service.

Fundamentals of Service (FOS) Manuals cover basic theory of operation, *fundamentals* of trouble shooting, *general* maintenance, and *basic* types of failures and their causes. FOS Manuals are for training new people and for reference by experienced technicians.

Technical Manuals are concise service guides for a specific machine. Technical Manuals are on-the-job guides containing only the vital information needed by an experienced technician.

NOTE: Whenever the service technician may need to refer to a FOS Manual for additional information, a specific manual number is given.

Some features of this technical manual:

- *Table of contents at front of manual*
- *Exploded views showing parts relationship*
- *Photos showing service techniques*
- *Specifications grouped for easy reference*



Use Technical Manuals for Actual Service

X2253N

This technical manual was planned and written for you—an experienced technician. Keep it in a permanent binder in the shop where it is handy. Refer to it whenever in doubt about correct service procedures or specifications.

Using the technical manual as a guide will reduce error and costly delay. It will also assure you the best in finished service work.

This safety alert symbol identifies important safety messages in this manual. When you see this symbol, be alert to the possibility of personal injury and carefully read the message that follows.

U.S. units of measure are shown with their respective Metric equivalents throughout this technical manual. These equivalents are the SI (International System) Units of Measure.

FOR YOUR CONVENIENCE

Vertical lines appear in the margins of many of the pages. These lines identify new material and revised information that affects specifications, procedures, and other important instructions.

RIGHT AND LEFT-HAND DETERMINATION

“Right-hand” or “left-hand” sides are determined by facing the direction the picker travels when in use.

**Thanks very much for your reading,
Want to get more information,
Please click here, Then get the complete
manual**

JustClickHere 

NOTE:

**If there is no response to click on the link above,
please download the PDF document first, and then
click on it.**

**Have any questions please write to me:
admin@servicemanualperfect.com**

SAFETY AND YOU



T27999N

T27999N

INTRODUCTION

 This safety alert symbol identifies important safety messages in this manual and on the picker. When you see this symbol, be alert to the possibility of personal injury and carefully read the message that follows.

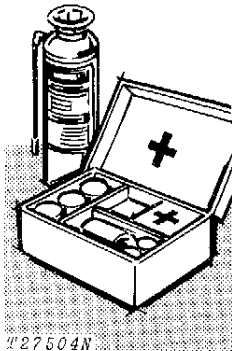

T27504N

T27504N

Be prepared if an accident or fire should occur. Know where the first aid kit and the fire extinguishers are located—know how to use them.

BLOCKING THE COTTON PICKER

 **CAUTION:** Whenever the engine is to be removed for service, it is very important that the basket be securely blocked so it will not fall and cause serious personal injury, or damage to the cotton picker.

Whenever working under the picking units, securely block the picking units so they will not fall and cause personal injury or damage to the units.

Always service the cotton picker on level ground unless otherwise specified in this manual.

Block the wheels to keep the cotton picker from moving while it is being serviced.

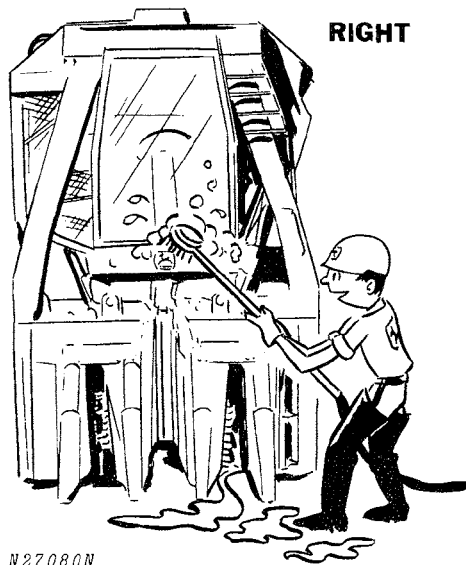
CLEANING THE COTTON PICKER

N27080N

N27080N

Always stop the engine before cleaning the cotton picker.

Keep the operator's platform clean. Do not use it as a storage area.

Keep the radiator and engine closure screens free of foreign matter. Avoid a possible fire hazard.

Keep all equipment free of dirt and oil. In freezing weather, beware of snow and ice on ladder steps and operator's platform.

SERVICE AREA

Keep the service area clean and dry. Wet or oily floors are slippery. Wet spots can be dangerous when working with electrical equipment.

Make sure the service area is adequately vented.

Periodically check the shop exhaust system for leakage. Engine exhaust gas is dangerous.

Be sure all electrical outlets and tools are properly grounded.

Use adequate light for the job at hand.

Use lifting equipment and safety stands with adequate capacity for the job being performed.

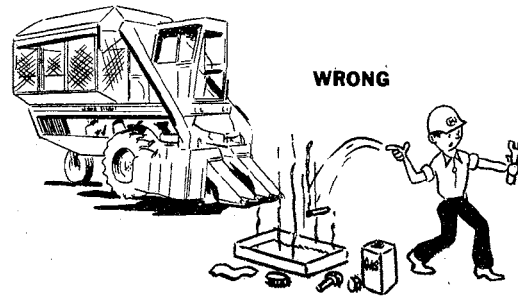
AVOIDING FIRE HAZARDS

N27081N

N27081N

Don't smoke while refueling or handling highly flammable material.

Shut off the engine when refueling.

Use care in refueling if the engine is hot.

Don't use open pans of gasoline or diesel fuel for cleaning parts. Good commercial, nonflammable solvents are preferred.

Provide adequate ventilation when charging batteries.

Don't check battery charge by placing metal objects across the posts.

Don't allow sparks or open flame near batteries.

Don't smoke near battery.

Never check fuel, battery electrolyte or coolant levels with an open flame.

Never use an open flame to look for leaks anywhere on the equipment.

Never use an open flame as a light anywhere on or around the equipment.

When preparing engine for storage, remember that inhibitor is volatile and therefore dangerous. Seal and tape openings after adding the inhibitor. Keep container tightly closed when not in use.

FLUIDS UNDER PRESSURE

Escaping fluid under pressure can have sufficient force to penetrate the skin, causing serious personal injury. Before disconnecting lines, be sure to relieve all pressure. Before applying pressure to the system, be sure all connections are tight and that lines, pipes and hoses are not damaged. Fluid escaping from a very small hole can be almost invisible. Use a piece of cardboard or wood, rather than hands, to search for suspected leaks.

If injured by escaping fluid, see a doctor at once. Serious infection or reaction can develop if proper medical treatment is not administered immediately.

Don't forget the hydraulic system or diesel fuel injection system may be pressurized! To relieve pressure, follow the instructions in the applicable section of this technical manual.

When checking hydraulic pressure, be sure to use the correct test gauge for the pressure in the particular system.

PERSONAL SAFETY

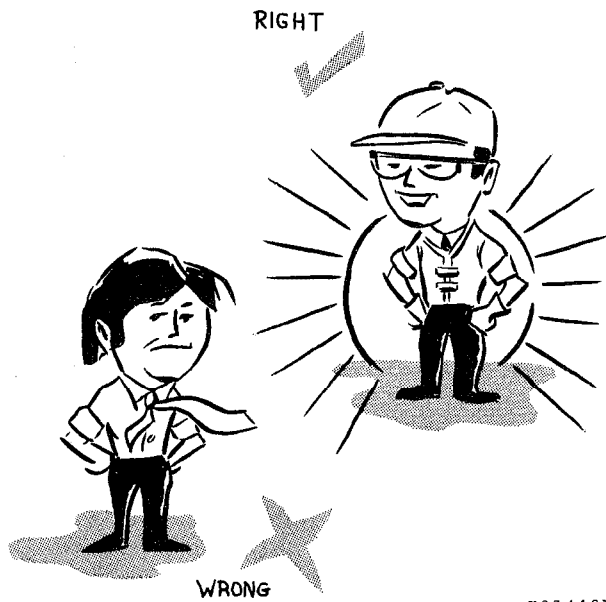

Always avoid loose clothing or any accessory—flopping cuffs, dangling neckties and scarves—that can catch in moving parts and put you out of work.

Always wear your safety glasses while on the job.

Keep transmission and brake control units properly adjusted at all times. Before making adjustments, stop engine.

Before removing any housing covers, stop engine. Take all objects from your pockets which could fall into the opened housings. Don't let adjusting wrenches fall into opened housings.

Don't attempt to check belt tension while the engine is running.

Don't adjust the fuel system while the machine is in motion.

Before repairing the electrical system, or performing a major overhaul, make sure the batteries are disconnected.

Avoid working on equipment with the engine running. If it is necessary to make checks with the engine running, ALWAYS USE TWO PEOPLE—with the operator, at the controls, able to see the person doing the checking. Also, put the transmission in neutral, set the brake, and apply any safety locks provided. **KEEP HANDS AWAY FROM MOVING PARTS.**

Use extreme caution in removing radiator caps, drain plugs, grease fittings, or hydraulic pressure caps.

Section 10 GENERAL

CONTENTS OF THIS SECTION

	Page		Page
GROUP 5 - GENERAL SPECIFICATIONS		GROUP 15 - TUNE-UP AND ADJUSTMENT	
Description	5-1	General Information	15-1
Serial Numbers	5-1	Preliminary Engine Testing	15-1
Specifications	5-2	Engine Tune-Up	15-1
		Adjustments	15-3
GROUP 10 - PREDELIVERY, DELIVERY AND AFTER-SALE SERVICES (9910)		GROUP 20 - LUBRICATION	
Predelivery Service	10-1	Lubricants	20-1
Delivery Service	10-23		
After-Sale Inspection	10-24	GROUP 25 - SPECIFICATIONS AND TORQUE VALUES	

Group 5 GENERAL SPECIFICATIONS

DESCRIPTION

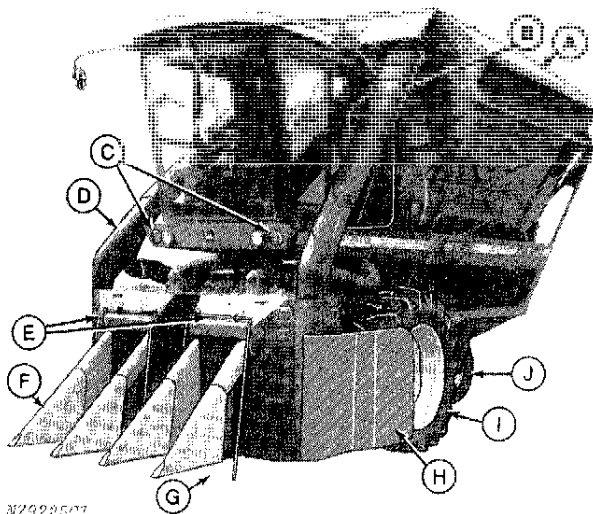

- | | |
|------------------------|------------------------------|
| A—Basket | F—Stalk Lifters |
| B—Ladder | G—Height Control Shoe |
| C—Warning Lamps | H—Wheel Shield |
| D—Suction Duct | I—Drive Wheel |
| E—Picking Units | J—Guide Wheel |

Fig. 1-9910 Cotton Picker

The 9900 and 9910 Cotton Pickers are two-row self-propelled cotton pickers having four basic components:

1. Picking units.
2. Cotton conveying system and basket.
3. Operator's platform.
4. Engine and propelling mechanism.

The picking units are either high-or low-drum and in row widths from 40-inch (1.02 m) solid-plant to 32-inch (0.81 m) skip-rows. The high-drum picking units have 1120 individual barbed spindles and the low-drum units have 784 spindles.

The cotton conveying system consists of a fan located in the engine area to convey the cotton to the basket which holds 3,000 lbs (1 361 kg) of seed cotton or 3,600 lbs (1 633 kg) of seed cotton with basket compactor.

The 9900 Cotton Picker is propelled by a 6-cylinder, 329 cu. in. (5 391 cm³) diesel engine; the 9910 by a 359 cu. in. (5 883 cm³) diesel engine.

SERIAL NUMBERS

The cotton picker serial number is on a plate located on the left-hand platform support.

The engine serial number is on a plate located on the left-side of the engine block.

The hydrostatic pump serial number is on a plate located on top of the pump.

The hydrostatic motor serial number is on a plate located on the left-hand side of the motor.

The cab serial number is located to the left of the operator's seat, on the cab frame.

SPECIFICATIONS

PICKING UNITS

Number of units	2
Number of picking drums	4
Number of picker bars (per unit)	
Front drum	16
Rear drum	12
Number of doffers and moisteners	
Low drum units	28
High drum units	40
Number of spindles (per machine)	
Low drum units (14 per bar)	784
High drum units (20 per bar)	1120

	Standard Transmission (rpm)		Hydrostatic Transmission (rpm)	
	9900	9910	9900	9910
PICKING UNIT SPEEDS (at 2500 engine rpm)*				
Picking unit countershaft				
Low range*	784	862	0-784	0-862
High range*	1046	1150	0-1046	0-1150
Picking drum				
Front drum (16 bar)				
Low range*	78	86	0-78	0-86
High range*	105	115	0-105	0-115
Rear drum (12 bar)				
Low range*	99	109	0-99	0-109
High range*	132	145	0-132	0-145
Doffer shaft				
Front drum (16 bar)				
Low range*	1266	1393	0-1266	0-1300*
High range*	1689	1858	0-1689	0-1734*
Rear drum (12 bar)				
Low range*	1285	1413	0-1285	0-1318*
High range*	1714	1885	0-1714	0-1759*
Spindle				
Front drum (16 bar)				
Low range*	2738	3011	0-2738	0-3011
High range*	3654	4017	0-3654	0-4017
Rear drum (12 bar)				
Low range*	2746	3020	0-2746	0-3020
High range*	3664	4030	0-3664	0-4030

*Cotton Pickers with Standard Transmission have a high and low picking unit range as standard equipment. With Hydrostatic Transmissions high range is standard equipment, low range may be added, and the picking unit speeds vary with the setting of the speed control lever. If necessary, increase engine rpm to maintain picking unit speeds. (See page 10-10-21.) Doffer shaft speeds for 9910 with hydrostatic transmission are for 1980 or later models equipped with 14-tooth doffer drive sprocket.

	Standard Transmission, mph (km/h)		Hydrostatic Transmission, mph (km/h)	
	9900	9910**	9900	9910**
GROUND SPEEDS (FULL THROTTLE)				
Picking speeds				
1st Gear	2.26 (3.6)	2.48 (3.99)	0-2.90 (0-4.7)	0-3.19 (0-5.13)
2nd Gear	2.90 (4.7)	3.19 (5.13)	0-3.42 (0-5.5)	0-3.76 (0-6.05)
3rd Gear	3.42 (5.5)	3.76 (6.05)		

**With 16.9 x 34 tires

MACHINE SPECIFICATIONS—Continued

	9900	9910
DIMENSIONS (Approximate)		
Length		
High drum		266-1/2 in. (6.769 m)
Low drum		266-15/16 in. (6.779 m)
Height		162-1/2 in. (4.128 m)
Width (With Wheel Shields)		103 in. (2.616)
Tread		
(Center-to-center R1 or R2 Tires)	79-5/8 in. (2.022 m)	
(Outside R3 Tires)	102 in. (2.591 m)	
(Center-to-center R1 or R3 Tires)		80-5/8 in. (2.048 m)
(Outside R2 Tires)		99-3/4 in. (2.534 m)
Under axle clearance	33 in. (838 mm)	35-1/2 in. (902 mm) (with 16.9 x 34 tires)
BASKET DUMPING HEIGHT (Approximate)		
Lip		9 ft. 10-1/2 in. (3.010 m)
Basket pivot		10 ft. 4 in. (3.149 m)
FINAL DRIVE		
Type		Pinion and ring gear
ELECTRICAL SYSTEM		
Battery voltage		12-volts
Battery terminal grounded		Negative
Alternator regulation		Electronic voltage regulator
ENGINE		
Manufacturer		John Deere
Type		Diesel
Model	6329 DN-03	6359 DN-01
No. of cylinders		6
Bore	4.02 in. (102 mm)	4.19 in. (106.5 mm)
Stroke		4.33 in. (110 mm)
Displacement	329 cu. in. (5 391 cm ³)	359 cu. in. (5 883 cm ³)
Horsepower	105 hp (78 kW)	114 hp (85 kW)
Compression ratio		16.8 to 1
Firing order		1-5-3-6-2-4
Tapped clearance		
Intake		0.014 in. (0.36 mm)
Exhaust		0.018 in. (0.56 mm)
Injection pump timing		Pin system
Engine speeds		
Fast idle (no load)		2650-2670 rpm
Rated (under field load)		2500 rpm
Slow idle		800 rpm ± 10 rpm
Governor		Integral with fuel injection pump
Air cleaner		Dry-type filter element with safety element and pre-screener
Oil filter		Spin-on, full-flow type
Cooling system		
Type		Liquid pressure
Radiator Cap Pressure		7 psi (0.5 bar [0.5 kg/cm ²])
Thermostat	195°F. (91°C.) (Replacement) 180°F (82°C) (Original)	Two, 180°F. (82°C.)

Group 10 PREDELIVERY, DELIVERY, AND AFTER-SALE SERVICES (9910)

PREDELIVERY SERVICES

The John Deere Delivery Receipt, when properly filled out and signed by the dealer and customer verifies that the predelivery and delivery services were satisfactorily performed. When delivering this machine, give the customer his copy of the delivery receipt and the operator's manual. Explain their purpose to him.

PREPARING COTTON PICKER FOR UNLOADING

NOTE: See page 10-10-5 for special assembly procedures required for truck shipments.

1. Check the cotton picker for shortages, loss or damage. If any is noted, make the proper notations on the freight bill, and immediately notify the carrier.
2. Remove the blocking and wiring that holds the cotton picker to the flat car during shipment.
3. Remove wires holding height sensing shoes in shipping position, and from cab door (if equipped).
4. Remove banding and shipping board from battery and attach positive cable to battery terminal.

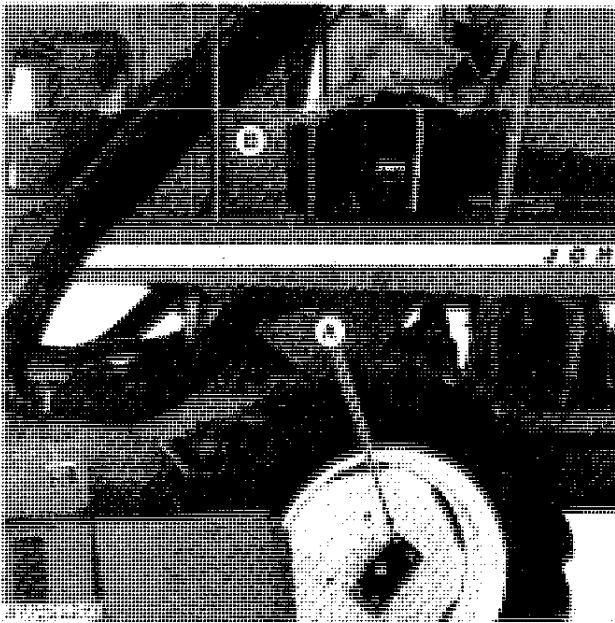

A—Tie Down Plate

B—Shields

Fig. 1-Tie-Down Plate, Wheel Lug Bolts, and Shields

5. **CAUTION:** Remove and DISCARD the tie-down plate (A, Fig. 1) from each drive wheel. Install the wheel lug bolts. Tighten ALL lug bolts to 160-200 ft-lbs (217-271 Nm [22-28 kgm]) torque.

6. Remove the rear plant shields (B) from their shipping location above the water tank. Set the shields aside for later installation.

Checking Crankcase Oil Level

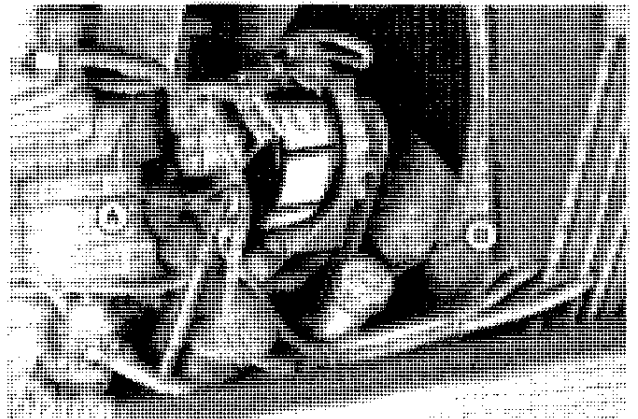

A—Dipstick

B—Crankcase Filler Cap

Fig. 2-Checking Crankcase Oil Level

Check the engine crankcase oil level with the dipstick. The picker is shipped with 12 qt. (11.4 L) of John Deere TORQ-GARD SUPREME® oil in the engine crankcase. If necessary, add TORQ-GARD SUPREME SAE 10W-20 engine oil until oil level is at "full" mark on the dipstick.

PREPARING COTTON PICKER FOR UNLOADING—Continued

Checking Hydraulic Oil Level

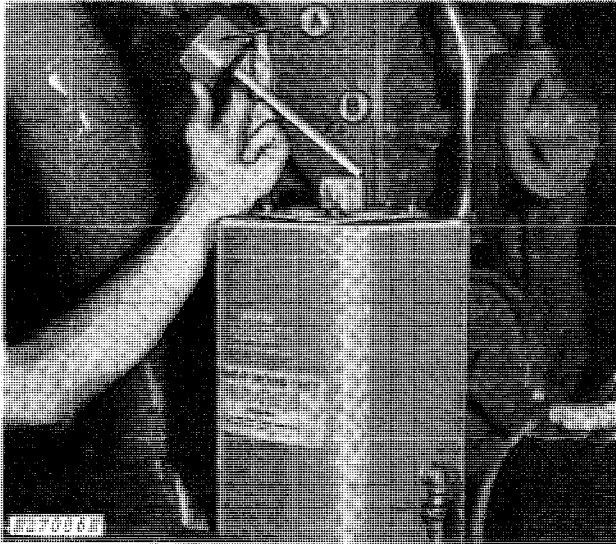

A—Hydraulic System Filler Cap

B—Dipstick

Fig. 3-Checking Hydraulic Oil Level

With the units lowered, remove the hydraulic system filler cap and check the oil level on the dipstick (B). If oil level is low, check for possible leaks or loose connections in the hydraulic system, then add HY-GARD® Transmission and Hydraulic Oil or its equivalent (See page 10-20-2), until the oil level is at the "full" mark on the dipstick.

Checking Transmission Oil Level

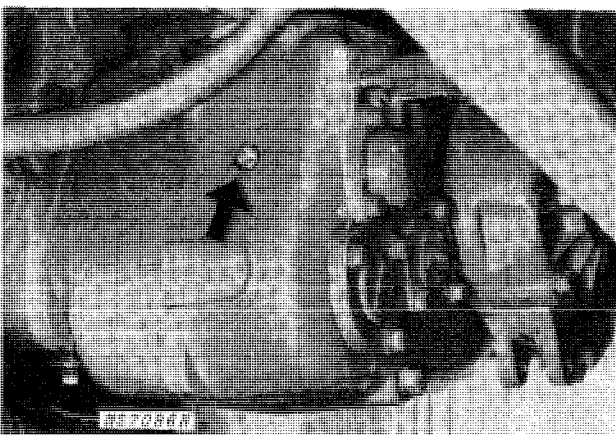

Fig. 4-Checking Transmission Oil Level

Check the oil level in the transmission using the level plug.

If oil level is low, add SAE 85W-140 gear lubricant until it reaches level plug. Replace the level plug.

IMPORTANT: Do not use SCL gear lubricant in this transmission. Do not overfill transmission.

Checking Hydrostatic Drive Reservoir Oil Level

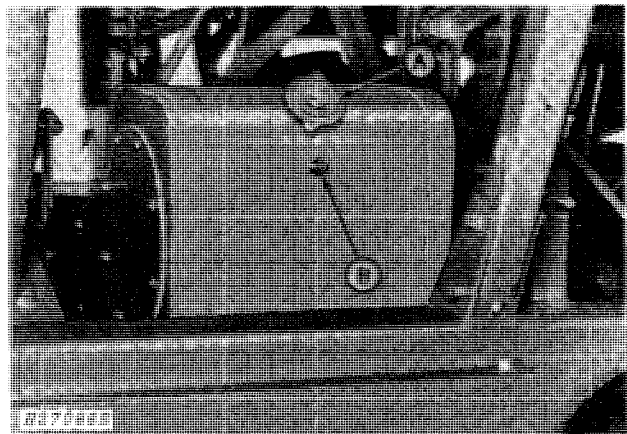

A—Filler Cap

B—Sight Glass

Fig. 5-Checking Hydrostatic Oil Level

Check the oil level in the sight glass (B). If oil level is low, add John Deere All Weather Hydrostatic Fluid or Texaco Type F-1876 Transmission Fluid until oil level is visible in sight glass. Replace filler cap.

IMPORTANT: Keep system closed at all times except when adding oil or changing or cleaning filters.

STARTING THE ENGINE

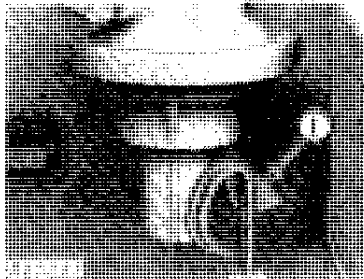

Fig. 6-Fuel Pump

N33291

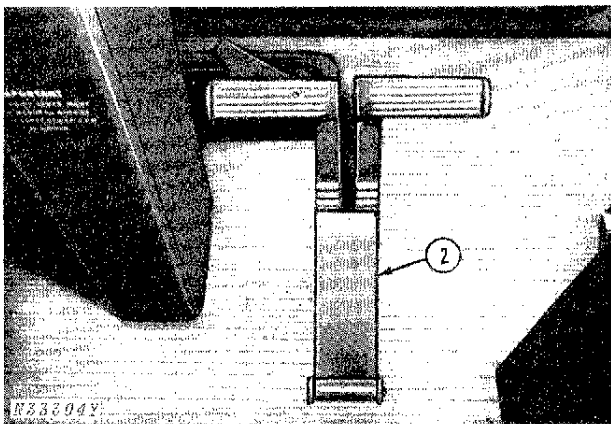

Fig. 7-Brake Latch

N33304Y

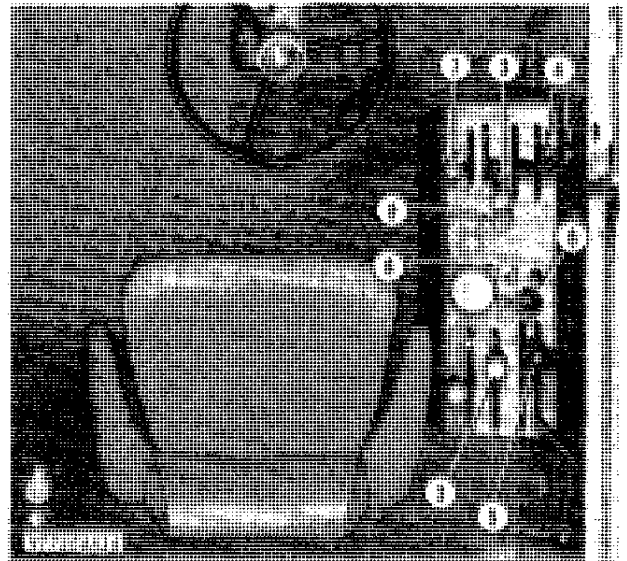

Fig. 8-Controls

N77284A14

Refer to Figs. 6, 7, and 8; then perform the following steps:

1. If engine has not been operated for a long time, work priming lever up and down to force fuel into the system.

Leave lever down during operation.

2. Set the picker brakes.

3. Position transmission gearshift lever in neutral. If equipped with hydrostatic drive, position speed range lever in neutral.

4. Pull unit lift levers rearward and release.

5. Disengage picking unit and fan levers.

6. IMPORTANT: Turn headlight and accessory switches off before attempting to start engine.

7. Advance throttle to full open; then bring it back about halfway.

8. Turn key switch.

Release key switch when the engine starts. If engine does not begin firing after 15 to 30 seconds of cranking, wait 2 minutes before cranking again.

9. Check oil pressure light to see that it goes out after the engine starts. Also check voltmeter pointer to see that it registers higher than with engine stopped, indicating that alternator is charging. If not, stop engine and correct the malfunction. (See Section 40).

10. Do not place engine under load until coolant temperature gauge shows that the engine has started to warm up. If indicator reaches red band on gauge, stop engine and correct the malfunction. (See Section 20, Group 30, or Section 40).

Checking Cooling System

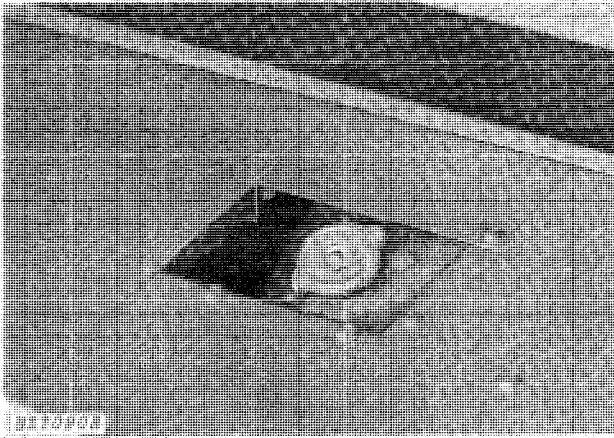

Fig. 9-Checking Cooling System

Check the radiator coolant level (Fig. 9). The cotton picker is shipped from the factory with a non-evaporating antifreeze protecting the cooling system to -34°F (-37°C). If necessary, add coolant to midway between core and cooler neck.

IMPORTANT: Do not use antifreezes with stop-leak additives.

Adjusting Tire Pressure

Adjust the tire pressure in the tires to the proper operating pressures as indicated below.

Wheel	Type of Tire	Tire Size	Inflation Pressure, kPa (psi)
Drive	R1 or R3	16.9-34 10 PR	200 (29)
Wheels	R2	18.4-30 10 PR	193 (28)
Guide Wheels	Rib	11.00-16 8 PR	276 (40)

Checking Miscellaneous Items

1. Check transmission and final drive housings for oil leaks.
2. Make sure the spindle wrench socket is wired to the platform.
3. Check battery to be sure it is charged.
4. With ignition switch ON, turn steering wheel to determine that guide wheel indicator lamp (green) is on ONLY when guide wheel is in a straight ahead position.

Bleeding Diesel Fuel System

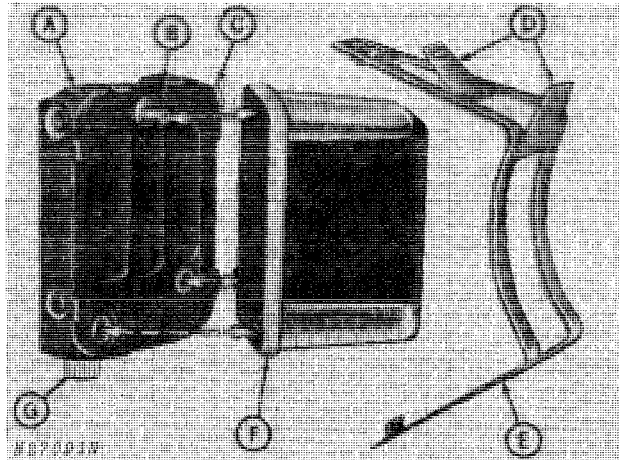

A—Filter Body
 B—Spring Pin
 C—Bleed Plug
 D—Finger Tabs

E—Filter Retaining Spring
 F—Filter Element
 G—Drain Plug

Fig. 10-Diesel Fuel Filter

To bleed the diesel fuel system, loosen the filter bleed plug (C, Fig. 10). Pump the primer lever on the fuel pump until the air bubbles in the filter (F) disappear and fuel flows from the bleed plug. Tighten the bleed plug and leave the primer lever in the down position.

Checking the Fuel Level

Check the fuel gauge (R, Fig. 54, page 10-10-19) to be sure there is sufficient fuel.

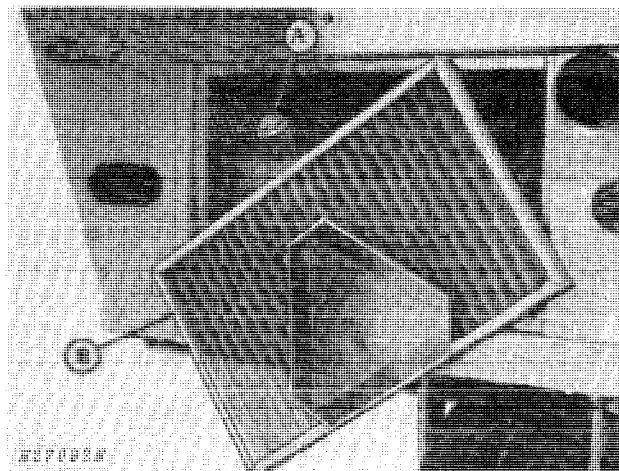

A—Fuel Tank Filler Cap

B—Screen

Fig. 11-Filling Fuel Tank

If fuel is required, position rear screen (B, Fig. 11) out of way and fill tank with diesel fuel. The fuel tank holds 69 U.S. Gallons (262 L).

UNLOADING COTTON PICKER FROM FLAT CAR

1. Raise picking units and remove all blocking from flat car.
2. Make sure the brakes are working before attempting to move picker.
3. Back picker down the unloading dock or ramp onto level ground.

⚠ CAUTION: Be sure to back down rather than drive down forward. Avoid accidents and damage to the picker.

PREPARING COTTON PICKER FOR UNLOADING FROM TRUCK

On some step-bed trailers, the rear guide wheel and/or yoke may have been removed for shipping. Install as noted below.

⚠ CAUTION: Use jacks or hoist with at least 3000 lbs. (1362 kg) capacity. Lift or support picker with stands applied to main frame members only.

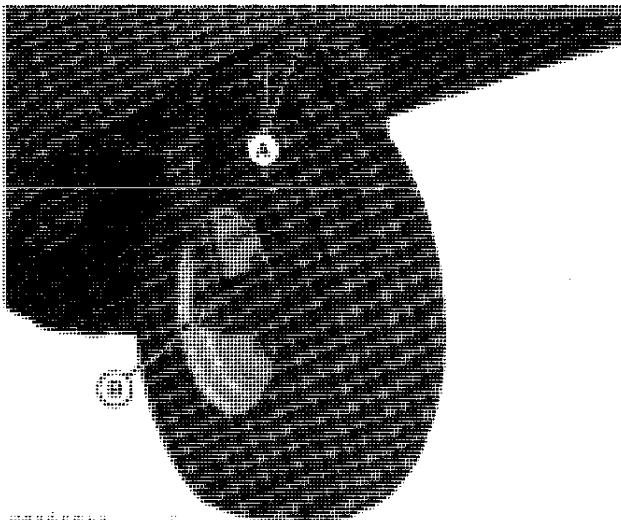

A — Cap Screws (Rear)

B — Hex Nut

Fig. 11A-Installing Yoke and Wheel

Install two 2-1/2 in. (64 mm) cap screws in the REAR holes of the yoke and steering motor (A, Fig. 11A). Use flat washers between heads of screws and steering indicator switch bracket. Tighten screws to 300 ft-lbs (407 N·m). Tighten guide wheel shaft nuts (B) to 250 ft-lbs (339 N·m) minimum.

NOTE: Refer to rebuild instructions received with truck shipments for special assembly information.

TEMPORARY STORAGE

After receiving cotton picker from the factory and before putting the machine into temporary storage, perform the following checks:

NOTE: For long term storage (over 30 days) information, consult the Operator's Manual.

1. Clean battery surfaces and disconnect cables. Charge battery, if necessary, or remove and store in a location which is safe from freezing temperatures.
2. Check level of coolant in the radiator. The coolant should be maintained midway between the radiator core and filler neck.
3. Fill fuel tank.
4. Check crankcase oil level. Oil should be at full mark after machine has been shut off for 10 minutes.
5. Relieve hydraulic pressure.
6. **IMPORTANT:** Check torque on ALL drive wheel hub bolts. Torque drive wheel bolts to 160-200 ft-lbs (220-270 N·m), guide wheel bolts to 110-140 ft-lbs (150-190 N·m).
7. Check tire pressure. See chart on page 10-10-4 for recommended pressures.

ASSEMBLY

NOTE: Refer to rebuild instructions received with truck shipments for special assembly information.

Stalk Lifters

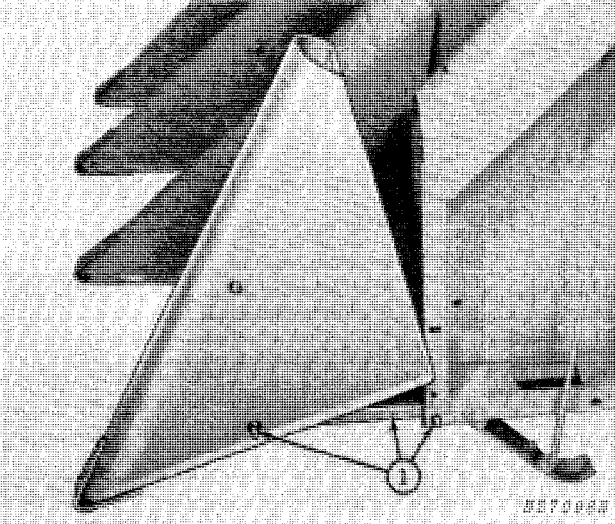

Fig. 12-Installing Stalk Lifter

1. Attach the stalk lifter bracket to the extension, using the long bolt and spacer. Install the bolt with the bolt head in the row. If necessary, invert long bolt at front end of bracket so that bolt head is also in the row.

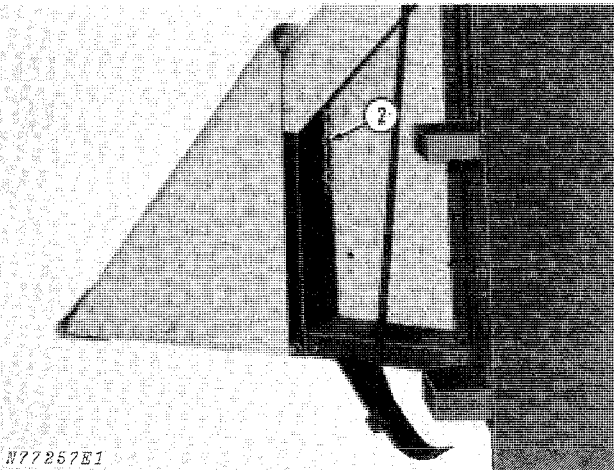

Fig. 13-Installing Chain

2. Install the chain in the slot on the unit extension. Drop enough links so the stalk lifter is level with the extension.

Installing Rear Plant Shields

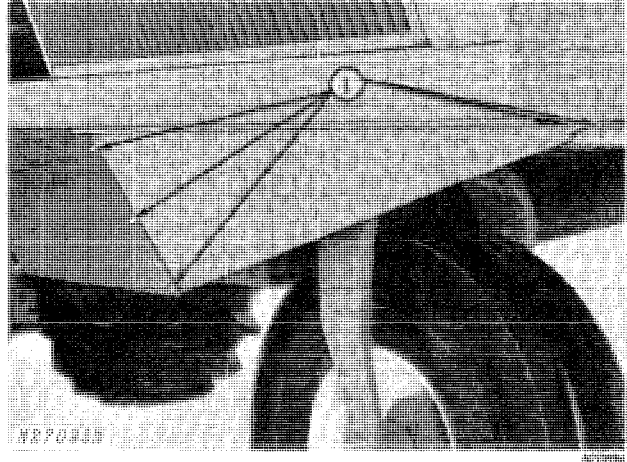

Fig. 14-Install Rear Plant Shields

1. Remove the two tie-down shipping straps from both sides at the rear of the main frame. Discard straps and bolts.

Install the right-hand and left-hand rear plant shields, using spin-lock screws furnished.

Basket Lid Linkage and Shipping Bolts

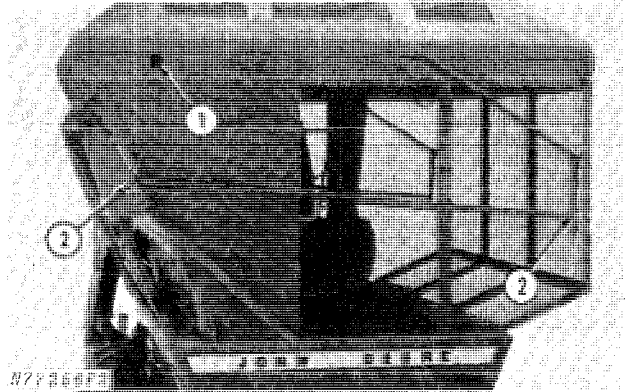

Fig. 15-Removing Lid Shipping Bolts

1. **IMPORTANT:** Remove the two red bolts which hold the basket lid to the basket frame. These bolts are reached from inside the basket and are flagged by the red metal tag at the front and rear of the basket. Extensive damage will result if the basket is raised with the red shipping bolts in place and lid linkage connected.

2. Remove wire holding lid linkage in shipping position. Install pivot bolts, from **INSIDE** basket support frames, through link, with a nut on each side of support, to allow link to pivot freely. Use outer hole in long link when attaching to short link, for standard lid opening. Use inner hole for larger lid opening.

IMPORTANT: Make sure front and rear linkages are pinned in the corresponding holes to prevent twisting of lid.

ASSEMBLY—Continued

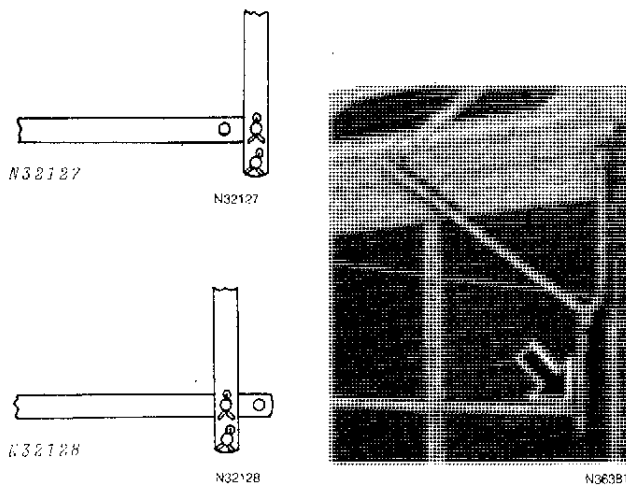

IMPORTANT: Pin front and rear linkage in same holes to prevent twisting of lid.

IMPORTANT: Both pins **MUST BE** installed in short linkage arm. Damage can occur to linkage and basket if **BOTH** pins are not used.

Basket Lift Lever

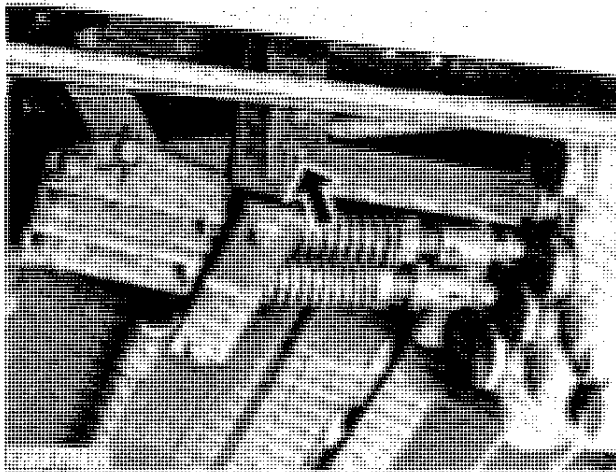
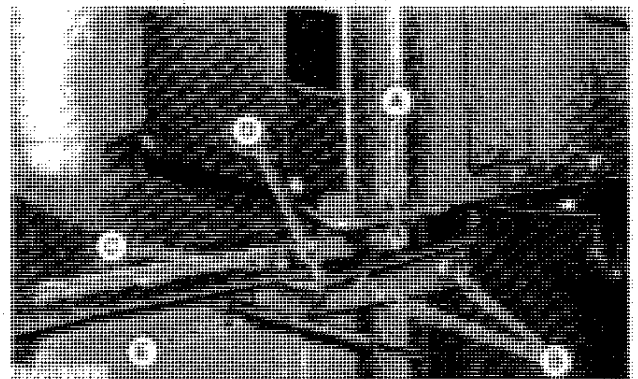

Fig. 16-Connecting Basket Lift Lever

1. The basket lift lever was disconnected for shipping. Connect the two straps at the valve to the lift lever with a pin (Fig. 16).

Drive Wheel Shields



- A—Brackets
- B—Bolt
- C—Pivot Bolt
- D—Stop Bolt
- E—Spring

Fig. 17-Installing Wheel Shields (Left Hand Shown)

1. Remove wheel shields from shipping position.
2. Attach top and bottom wheel shield brackets (A, Fig. 17) to each unit with two bolts (B) each.
3. Locate top and bottom pivot bolt (C) and install with wheel shield.
4. Install top and bottom stop bolt (D) and adjust so the wheel shield does not rub the tire.
5. Install top and bottom springs (E).

Picking Unit Lift (Without Automatic Height Control)

If the picking units are to operate individually, they do not require any change. If the units are to operate simultaneously, proceed as follows:

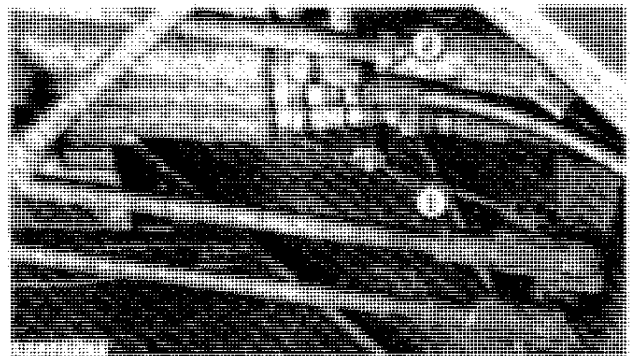

Fig. 18-Changing Valve Connections

CAUTION: Relieve hydraulic pressure before removing outlet cap or hose.

1. Remove cap from right-hand outlet (Fig. 18) of main control valve.
2. Remove hose from center outlet.